

CSB-PCC® Plastic Cable Chains

CSB-PCC® 工程塑料电缆拖链

附件 | 分隔片 Accessories | Separators

■ C02竖分隔片 Vertical separators



- 分隔片，将链内空间按需要分隔开电缆、油管、气管等起到保护作用
- 具有较高强度的分隔片，可稳固的装备于拖链中
- 同时满足安装简单快速
- The separator separates inside space of the chain to protect cables, oil hoses, gas hoses, etc.
- Separator with high strength, can be firmly fitted in chain
- Quickly and easily installation

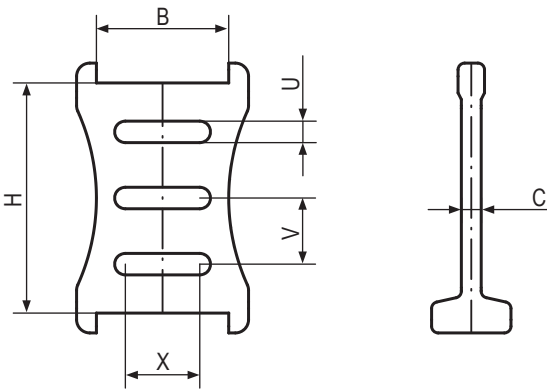

产品编码 Part No.:

SV1.C02.25
 拖链内高 Inner Height
 拖链型号 Chain type
 分隔片系列 Separator series

产品编码 Part No.	H _{0.25}	X	V	C	U	B
SV1.C02.25	25	11.3	/	2.5	3.3	20
SV1.C02.35	35	11.3	10	3	3.3	7.5
SV1.C02.45	45	11.3	10	3	3.3	22



可沿横杆自由移动
 Move freely along the crossbar

附件 | 分隔片 Accessories | Separators
■ C03竖分隔片 Vertical separators

- 分隔片，将链内空间按需要分隔开电缆、油管、气管等起到保护作用
 - 具有较高强度的分隔片，可稳固的装备于拖链中
 - 同时满足安装简单快速
- The separator separates inside space of the chain to protect cables, oil hoses, gas hoses, etc.
 - Separator with high strength, can be firmly fitted in chain
 - Quickly and easily installation

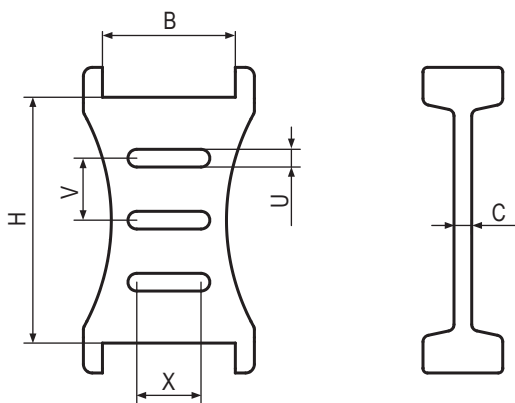

产品编码 Part No.:

SV1.C03.32

- 拖链内高 Inner Height
- 拖链型号 Chain type
- 分隔片系列 Separator series

产品编码 Part No.	H _{0.25}	X	V	C	U	B
SV1.C03.32	32	11.3	/	3	3.3	26
SV1.C03.42	42	11.3	10	3	3.3	26
SV1.C03.56	56	11.3	10	4	3.3	30



可沿横杆自由移动
Move freely along the crossbar

CSB-PCC[®] Plastic Cable Chains

CSB-PCC[®] 工程塑料电缆拖链

附件 | 分隔片 Accessories | Separators

■ 横分隔片 Horizontal separators



- 可用于许多直径电缆应用，横分隔片可以放置适合宽度
- C03.42和C03.56提供了3个不同高度横向分隔槽位
- 横分隔片中的竖分隔片可在水平方向自由移动
- Horizontal separators are available for many diameter cable applications
- Three different height for C03.42 and C03.56
- The vertical separator in the horizontal separator can move freely in the horizontal direction

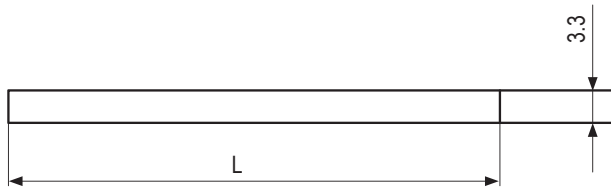

产品编码 Part No.:

SC1.C02.57

拖链内宽 Inner width

拖链系列 Chain series

分隔片系列 Separator series

产品编码 Part No.	C02.25 Bi	C02.35 Bi	C02.45 Bi
SC1.C02.Bi	57-125	50-175	80-250

产品编码 Part No.	C03.32 Bi	C03.42 Bi	C03.56 Bi
SC1.C03.Bi	50-200	50-200	75-300



可沿横杆自由移动
Move freely along the crossbar

最多可安装3片
Max. installation quantity: 3pcs

附件 | 消除应力元件 Accessories | Strain relief elements

C02 C型支架 C-profile brackets

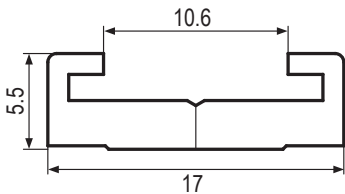

- 铝合金材质，表面阳极氧化
- 消除应力元件可在导向槽内运动
- Aluminum alloy, surface anodized
- The tiwrap elements can move within the guide slot

产品编码 Part No.:

CB1.C02.57

- 拖链内宽 Inner width
- 拖链系列 Chain series
- 支架系列 Bracket series

C02 消除应力元件 Tiewrap elements

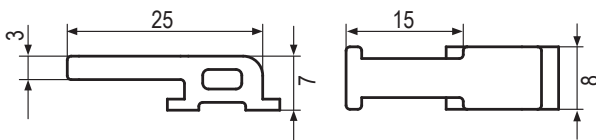

- 作为独立部件供货
- 适用C型支架，带梳齿状应力元件
- 更方便固定电缆，易于拆装
- 节约安装时间，空间、成本，紧凑的模块化设计
- Available as an individual component
- Can be clipped into C-profile bracker
- Easy to assemble and fix cables
- Save assemble time and space,compact modular design

产品编码 Part No.:

TE1.C02.57

- 拖链内宽 Inner width
- 拖链系列 Chain series
- 去应力元件系列 Tiewrap elements series

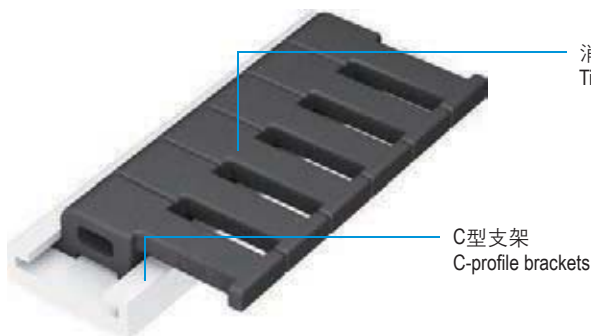

CSB-PCC® Plastic Cable Chains

CSB-PCC® 工程塑料电缆拖链

附件 | 消除应力元件 Accessories | Strain relief elements

■ C03 C型支架 C-profile brackets

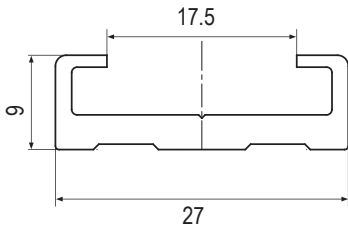

- 铝合金材质，表面阳极氧化
- 消除应力元件可在导向槽内运动
- Aluminum alloy, surface anodized
- The tiewrap elements can move within the guide slot

产品编码 Part No.:

CB1.C03.50

- 拖链内宽 Inner width
- 拖链系列 Chain series
- 支架系列 Bracket series

■ C03 消除应力元件 Tiewrap elements

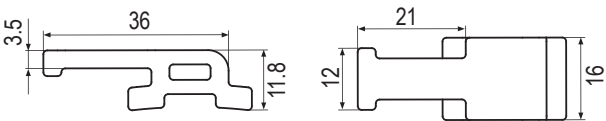

- 作为独立部件供货
- 适用C型支架，带梳齿状应力元件
- 更方便固定电缆，易于拆装
- 节约安装时间，空间、成本，紧凑的模块化设计
- Available as an individual component
- Can be clipped into C-profile bracker
- Easy to assemble and fix cables
- Save assemble time and space,compact modular design

产品编码 Part No.:

TE1.C03.50

- 拖链内宽 Inner width
- 拖链系列 Chain series
- 去应力元件系列 Tiewrap elements series

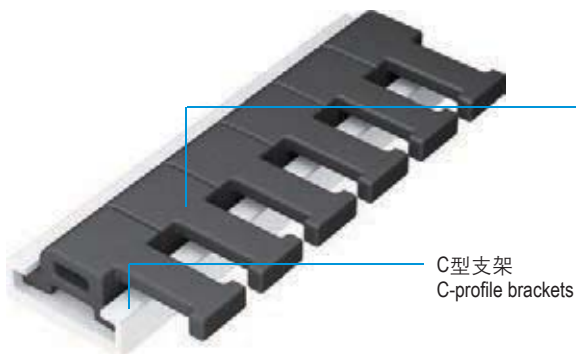

消除应力元件
Tiewrap elements

C型支架
C-profile brackets